



Department of  
Aging



Department of  
Health



Department of  
Developmental Disabilities



Department of  
Medicaid

# Hospital-Community Collaboration Next Steps COVID-19 Response **Meeting will Begin at 7:00 AM**

April 20, 2020



**MIKE DEWINE**  
GOVERNOR OF OHIO

# Housekeeping

- All attendees are in listen-only mode
- Please submit questions through the Q&A function.
  - » *We won't answer Q&A during this webinar, but will provide follow up information.*
- Resource documents sent following the webinar:
  - » LTSS Pre-Surge Planning Toolkit
  - » Health Care Isolation Center Plan
  - » Protocol for Facilitating Local Hospital-Facility-LHD Coalition
  - » Checklist for Local Coalition Readiness
  - » Slides from this presentation

# Agenda

- Governor's Remarks
- Comments Dr. Acton
- Update on action to date
- What is the data telling us
- Protocol for Hospital-Local Collaborative
- Example Zone 1 University Hospital & NF partnership
- Next Steps

# THE PATH FORWARD TO **RESTART**



**MIKE DEWINE**  
GOVERNOR OF OHIO



[coronavirus.ohio.gov](https://coronavirus.ohio.gov)



# NOT Black Diamond Ski

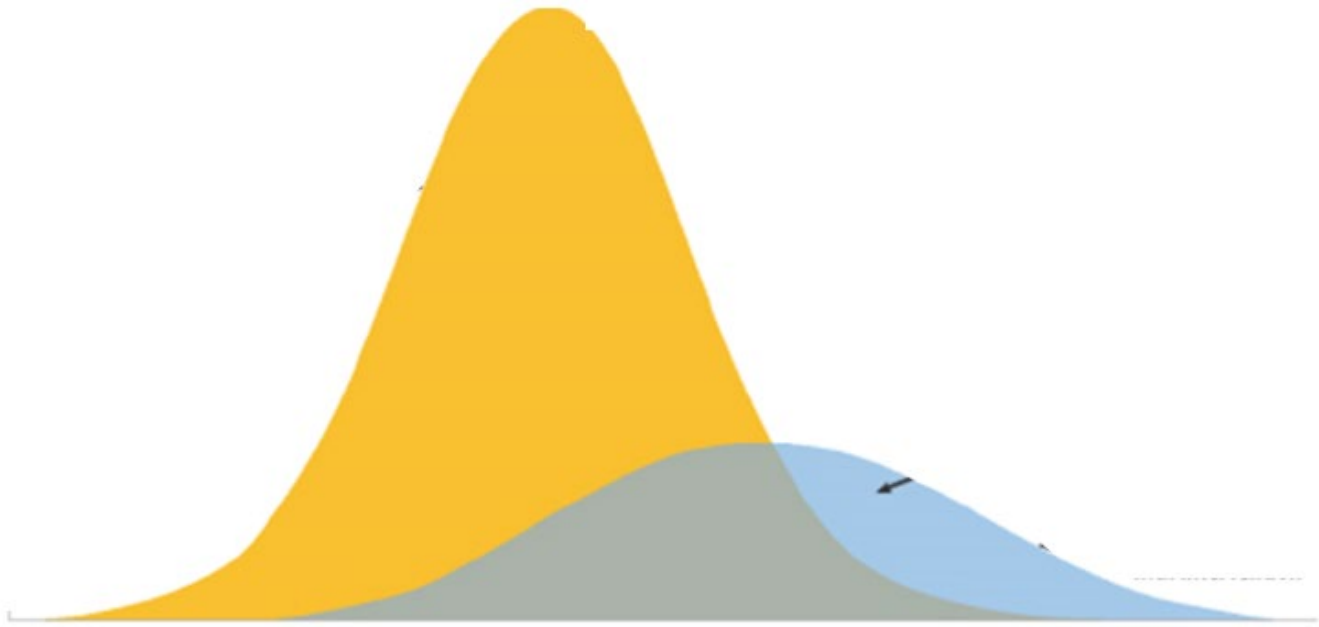

# MOGULS



# COMMUNICATION/ACTION



## Collaborative Effort: Community/Waiver & Facility

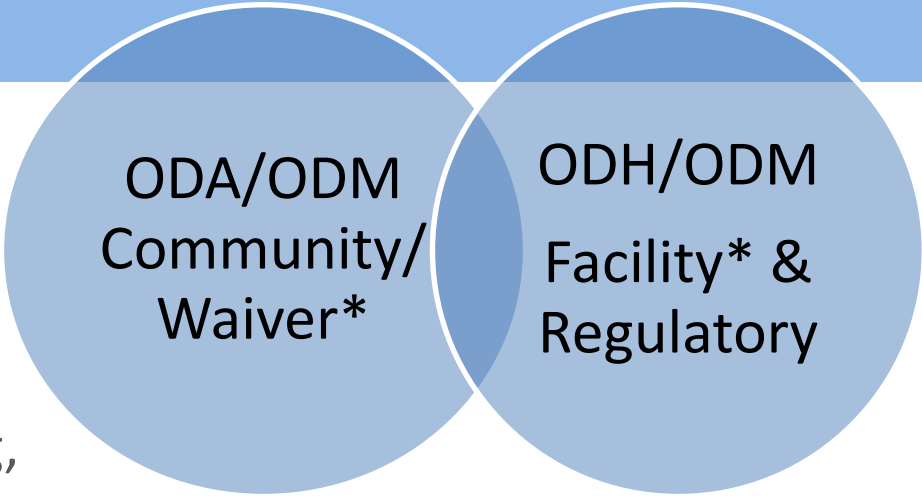

ODA/ODM  
Community/  
Waiver\*

ODH/ODM  
Facility\* &  
Regulatory

- ODA Weekly Conference Calls w/ Area Agency Aging, home & community/home health providers, nursing facilities
- Weekly meetings ODH/Regulatory with NF Associations
- Regular meetings with DODD and constituents
- **Facility Work Sessions with large group of association staff and clinical/administrative leaders**
  - **Toolkit**
  - **Developing HealthCare Isolation Center program**
- Meetings with Associations: NF, Assisted Living, Developmental Disability
- Meetings with Hospital Zone and NF/Facility association and member/leaders
- Meeting with 175 hospital reps from across the state
- Dr Applegate & Hurst and regulatory/epi staff from ODM/ODH have done numerous consultations



# Created COVID Toolkit, Protocols, Resources & Training:

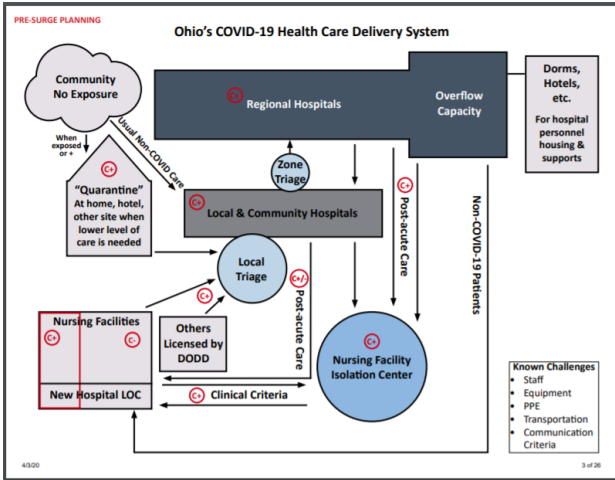

## Toolkit Components

### Concepts and System Flow Diagrams

- Introduction to Key Terms and Concepts
- Ohio's COVID-19 Health Care Delivery System
- Long Term Services & Supports (LTSS) Personal Protective Equipment (PPE) Contingency Planning
- Patient/Resident Journey in Nursing Facility / Congregate Care Settings
- COVID-19+ Patient Journey into Higher Levels of Medical Care
- Staff Journey in Nursing Facilities / Congregate Care Settings
- Patient/Resident Journey in Community Settings
- Staff Journey in Community Settings

### Tools

1. Patient/Resident Population Assessment Checklist
2. Personnel Population Risk Assessment Checklist
3. Assessment of COVID-19 + Clinical Level of Severity (NEWS2)
4. Scoring Matrix for NEWS2
5. COVID-19 Symptom Monitoring Log
6. Patient/Resident Transfer Checklist
7. Hospital Discharge Criteria Checklist
8. Tips for Patient/Resident Social and Emotional Wellbeing
9. Tips for Staff Social and Emotional Wellbeing
10. Tips for Staff Attire and Personal Protective Equipment (PPE)
11. PPE Quick Guide - Contingency Capacity
12. PPE Quick Guide - Crisis Capacity
13. Tips for Cleaning and Disinfecting Homes and Congregate Care Settings

## PPE RESOURCES AND TRAINING & VIDEOS

**TOOL 12: PPE Quick Guide Crisis Capacity**

Exposure Status	PPE Requirements
<b>No Exposure No Symptoms</b>	<ul style="list-style-type: none"> <li><b>Mask:</b> surgical/medical facemask preferred, extended use/re-use all shift.                             <ul style="list-style-type: none"> <li>When no approved facemask is available:                                     <ul style="list-style-type: none"> <li>Face shield with available mask</li> <li>Non-NIOSH approved mask (e.g. non-medical or handmade)</li> </ul> </li> </ul> </li> <li><b>Eye protection:</b> only for routine precautions</li> <li><b>Gown:</b> only for routine precautions</li> <li><b>Gloves:</b> only for routine precautions</li> </ul>
<b>Exposed No Symptoms</b>	<ul style="list-style-type: none"> <li><b>Mask:</b> surgical/medical facemask, extended use/re-use all shift.                             <ul style="list-style-type: none"> <li>When no approved facemask is available:                                     <ul style="list-style-type: none"> <li>Face shield with available mask</li> <li>Non-NIOSH approved mask (e.g. non-medical or handmade)</li> </ul> </li> </ul> </li> <li><b>Eye protection:</b> extended use/re-use safety glasses</li> <li><b>Gown:</b> extended use/re-use of disposable or cloth gowns; dedicated to resident or room with like residents (no additional infection ex: C. diff)                             <ul style="list-style-type: none"> <li>Consider medical coveralls; when no gowns are available: consider reusable/washable patient gowns, lab coats (worn backwards)</li> </ul> </li> <li><b>Gloves:</b> non-medical, industrial</li> </ul>
<b>COVID-19+ Confirmed or Suspected</b>	<ul style="list-style-type: none"> <li><b>Mask:</b> surgical/medical facemask, extended use/re-use all shift*                             <ul style="list-style-type: none"> <li>N95 only with aerosol-generating procedures</li> </ul> </li> <li><b>Eye protection:</b> extended use/re-use safety glasses</li> <li><b>Gown:</b> extended use/re-use of disposable or cloth gowns; dedicated to resident or room with like residents (no additional infection ex: C.diff)                             <ul style="list-style-type: none"> <li>Consider medical coveralls; when no gowns are available: consider reusable/washable patient gowns, lab coats (worn backwards)</li> </ul> </li> <li><b>Gloves:</b> Non-medical, industrial</li> </ul>

\*Unless contaminated (wet, soiled, damaged)

**OHIO MEDICAID** Nursing-Facility Focused LTSS Toolkit ... Watch later Share

**NURSING FACILITY-FOCUSED**

LTSS TOOLKIT BRIEFING

## Regulatory Relief: Community/Waiver & Facility

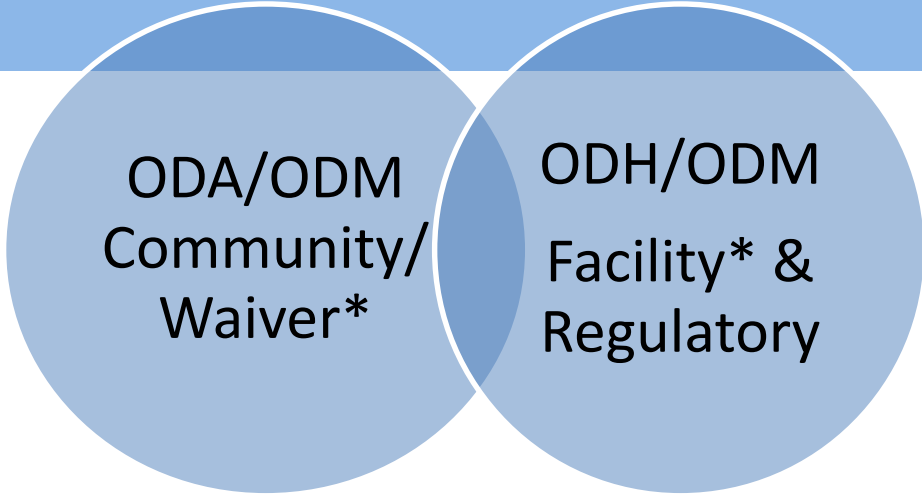

ODA/ODM  
Community/  
Waiver\*

ODH/ODM  
Facility\* &  
Regulatory

### FACILITY

- Facility/NF Associations: review of every request from every letter
- Multitude of regulatory relief: 1135 ODH, 1135 ODM, Emergency rules/journal for relief
- Meetings with Associations and Clinical/Administrative leaders
- Inclusion of DODD and ICF/IDD

### HOME & COMMUNITY

- Case management guidance, other health and safety
- DODD & County Board collaboration with providers
- Telehealth and telehealth waiver guidance
- Medicaid 1135 and Appendix K submission

# ROLE OF DATA

# State Operated Facilities

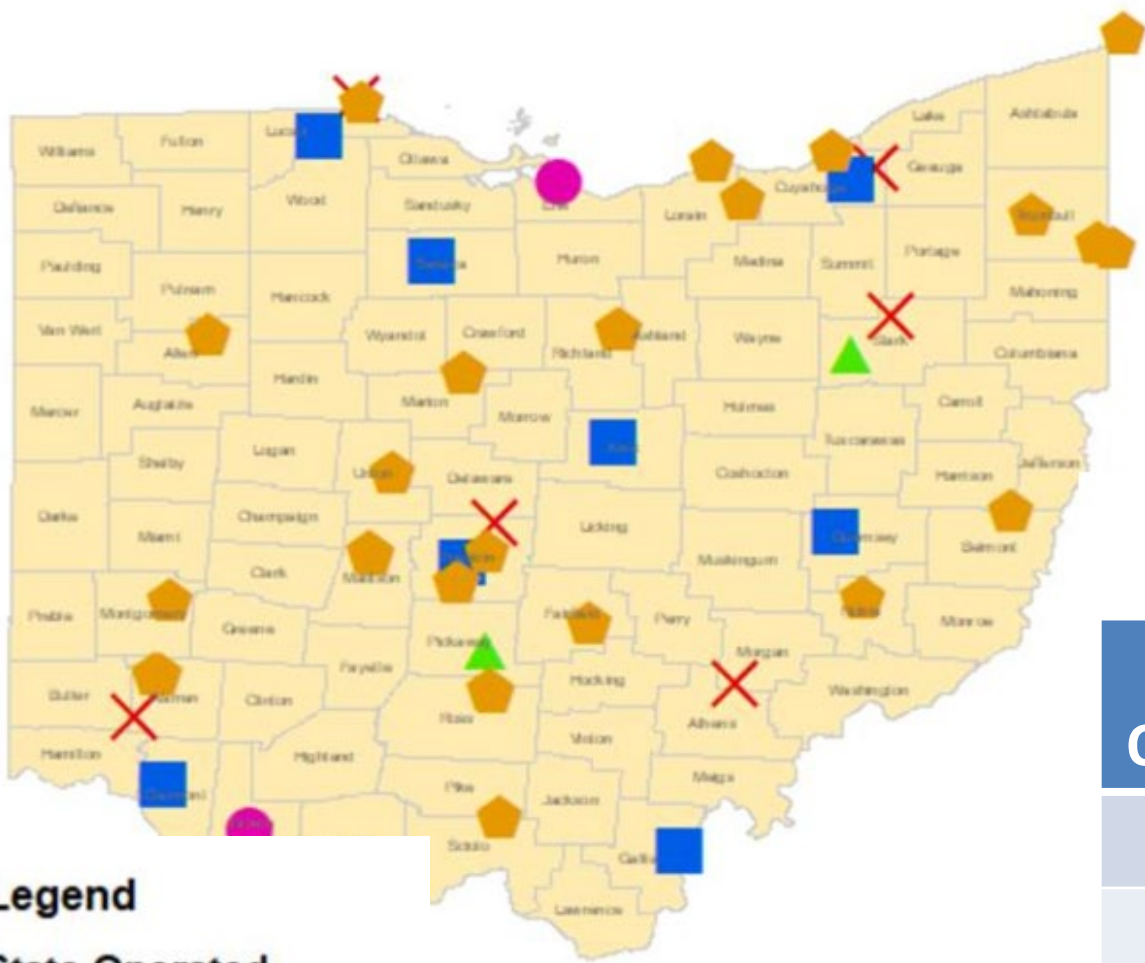

## Legend

### State Operated

### Facility Type

- DVS
- Developmental Centers
- ▲ JCF
- ⬠ Prisons
- ✕ State Psych Hospital

STATE OPERATED	PATIENTS/ RESIDENTS	STAFF	NUMBER OF FACILITIES
DRC	48,572		28
DODD	611	1938	8
DMHAS	929	1458	6
DYS	714	676	3
DVS	667	786	2

# Privately Operated Congregate Living Facilities

- Skilled Nursing Facilities
- Assisted Living
- Residential Care Facilities
- ODMHAS Licensed Treatment Facilities
- Substance Use Residential Treatment
- ICF/IDD and larger DD community homes
- Children's Residential Treatment, inc. DYS
- Also Senior Housing, Homeless Shelters, etc.

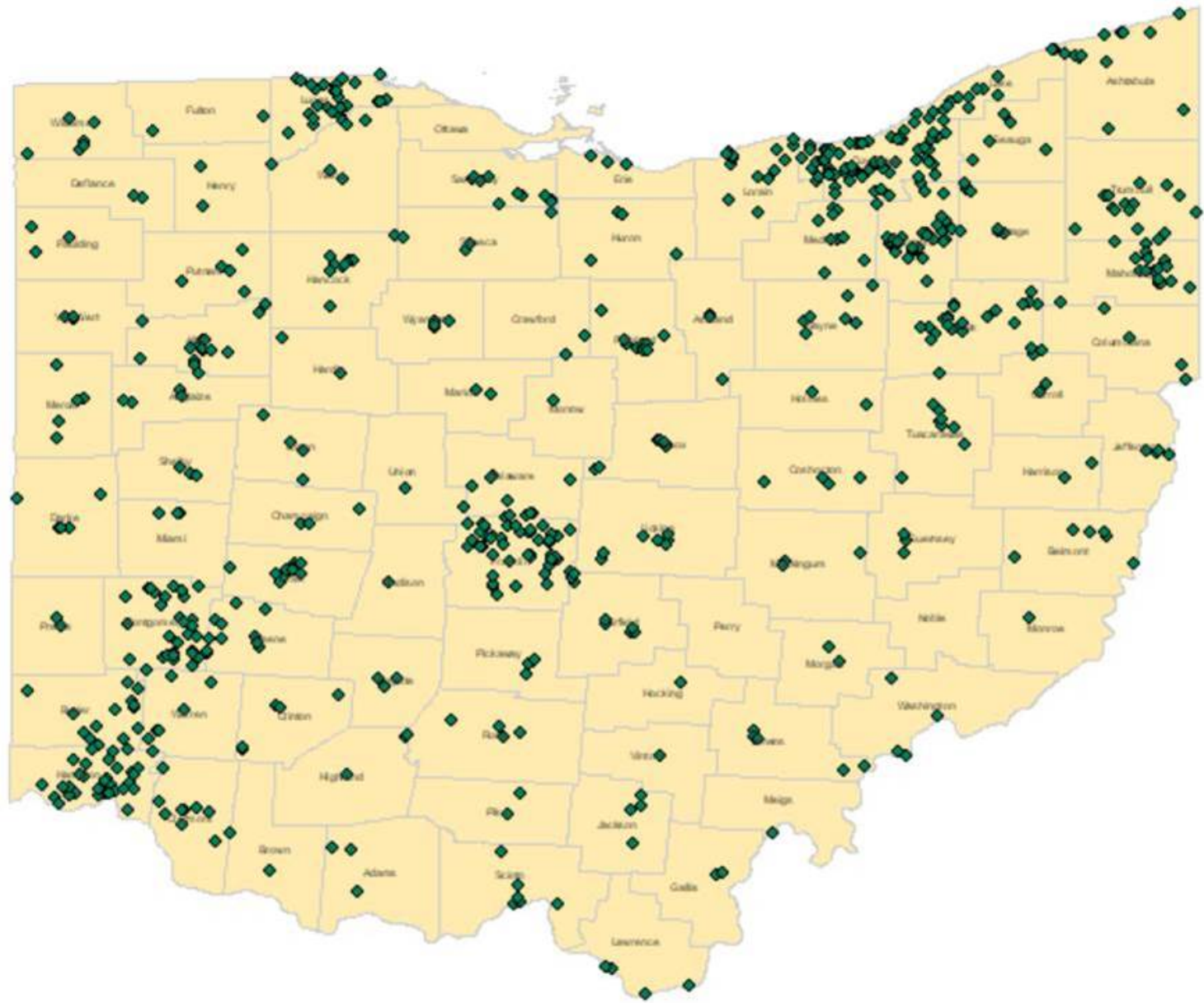

# Nursing Facility Response and Coverage

This is a map of where we have responses relative to the total facilities in the county that should have responded.

The darker the county the lower the completion rate of possible NF responses

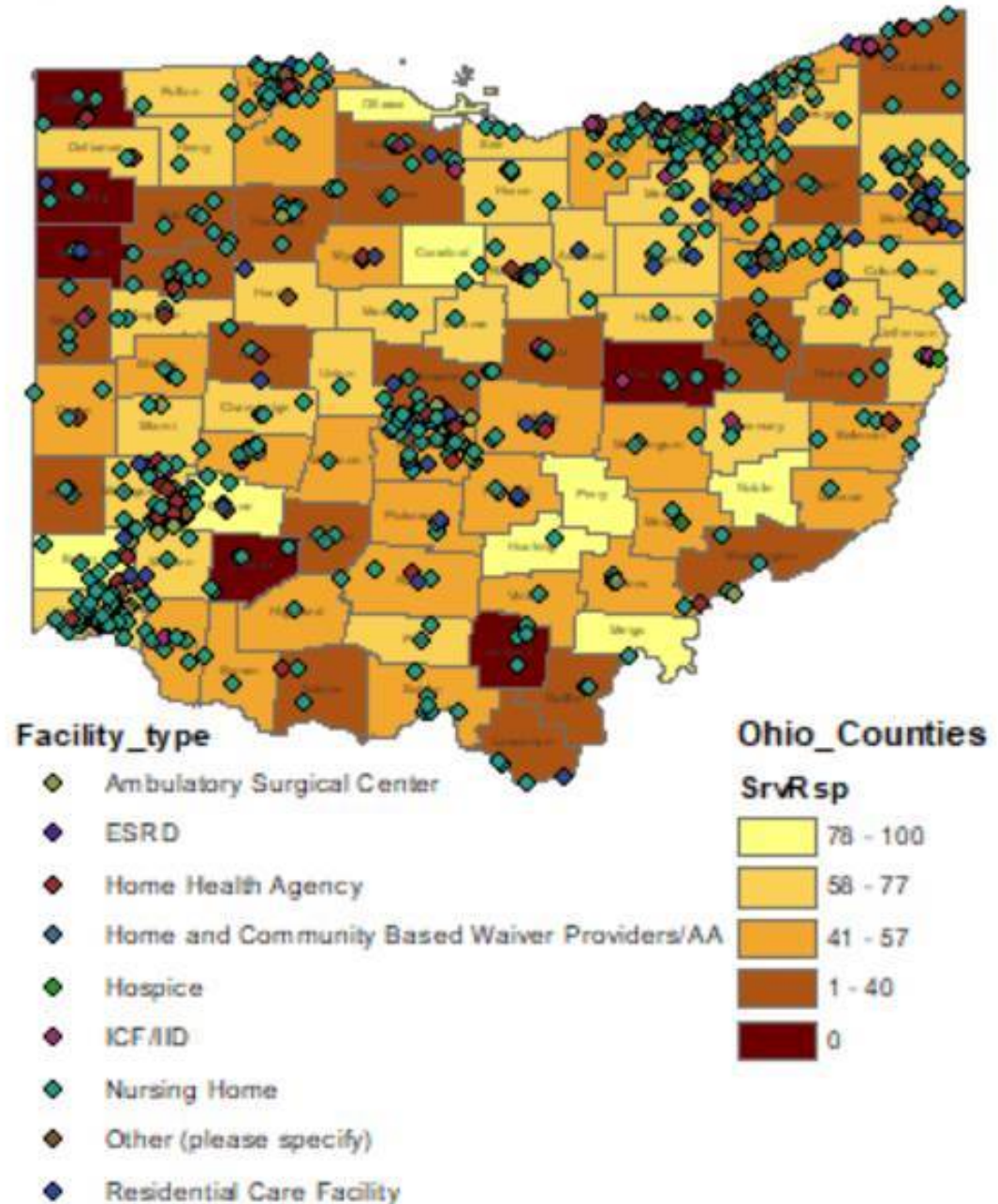

# All Reporting NF, ICF-IDD, Assisting Living: Available PPE

WITH ONE OR MORE PRESUMED COVID+

	MED MASK	N95	GOWNS	GLOVES
0-1 DAYS	4	6	5	
2-3 DAYS	9	7	11	1
4-7 DAYS	15	26	28	17
8-14 DAYS	27	17	20	35
15+ DAYS	47	33	37	47

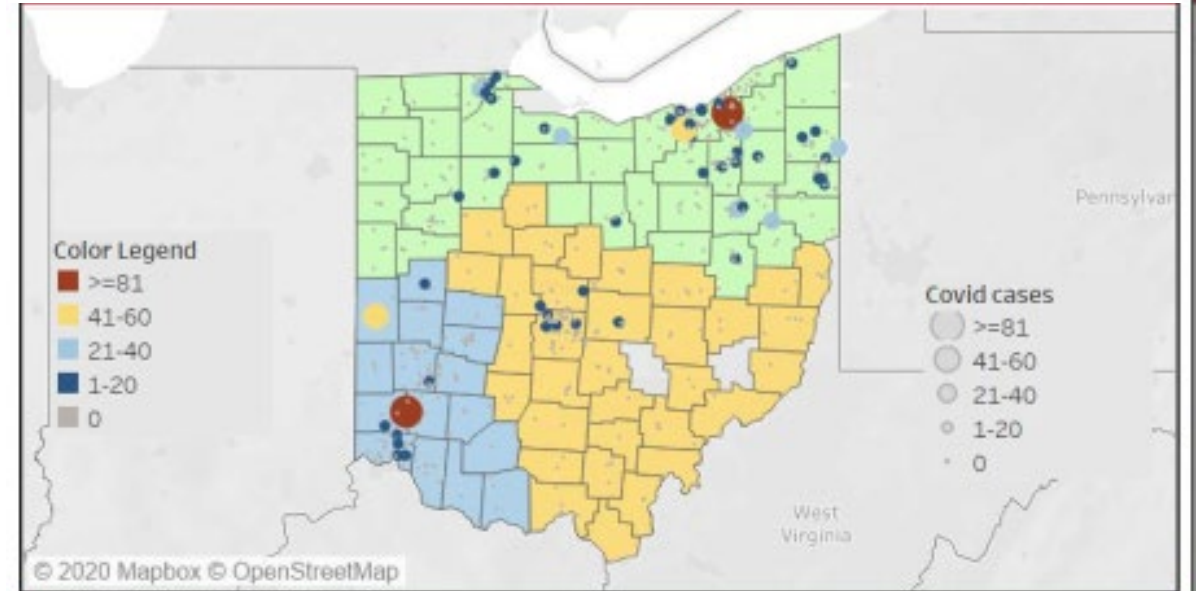



Grey base layer is the at risk population (counts within the zip code) – respiratory, obesity, and heart conditions).

The grey dots are where there are no reported cases. The darker colors are where there are known C19 cases.

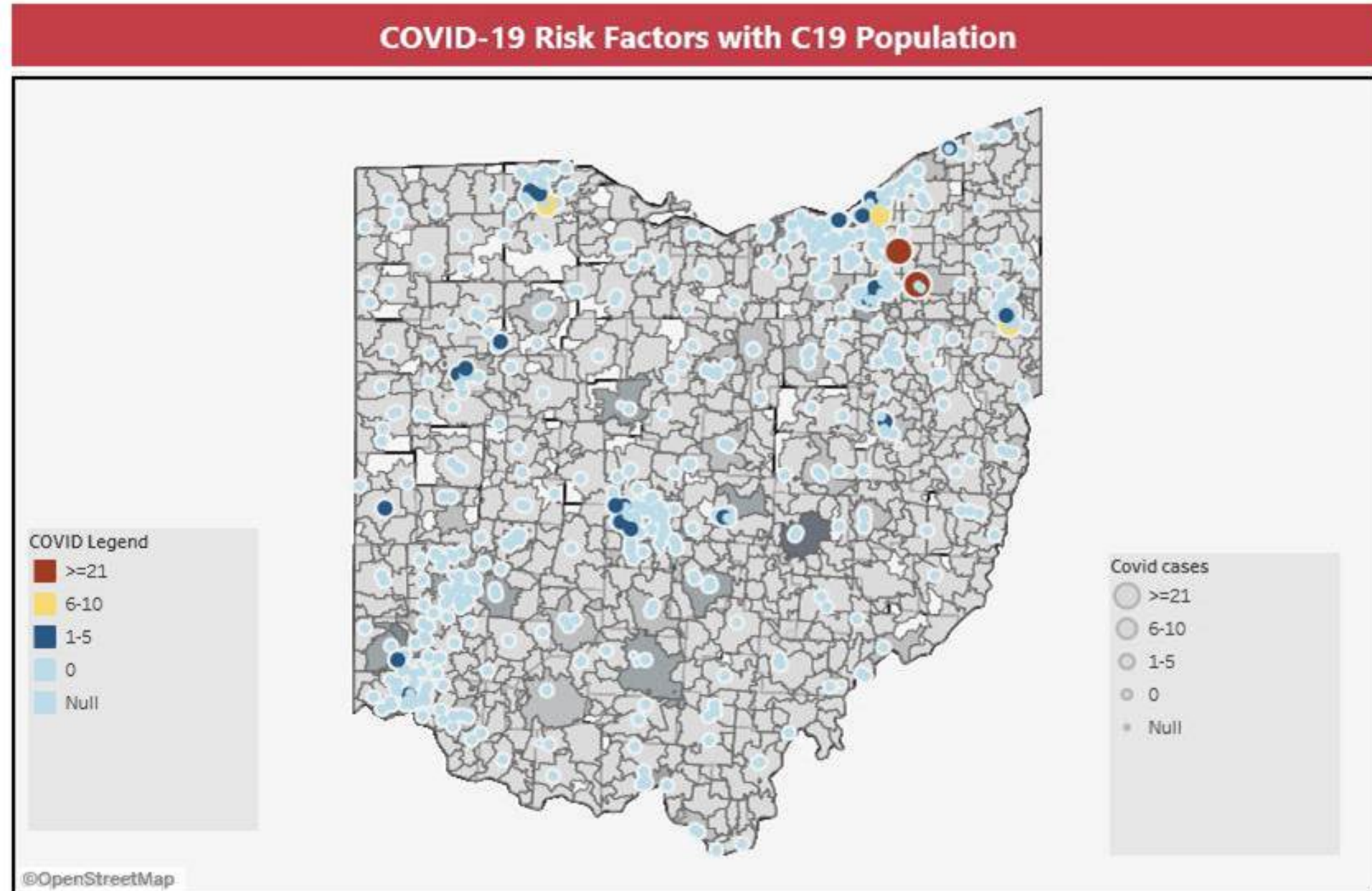

## COVID-19 Risk Factors with C19 Population

Compare that to where testing has already begun.

You can see them start to popup all around the state.

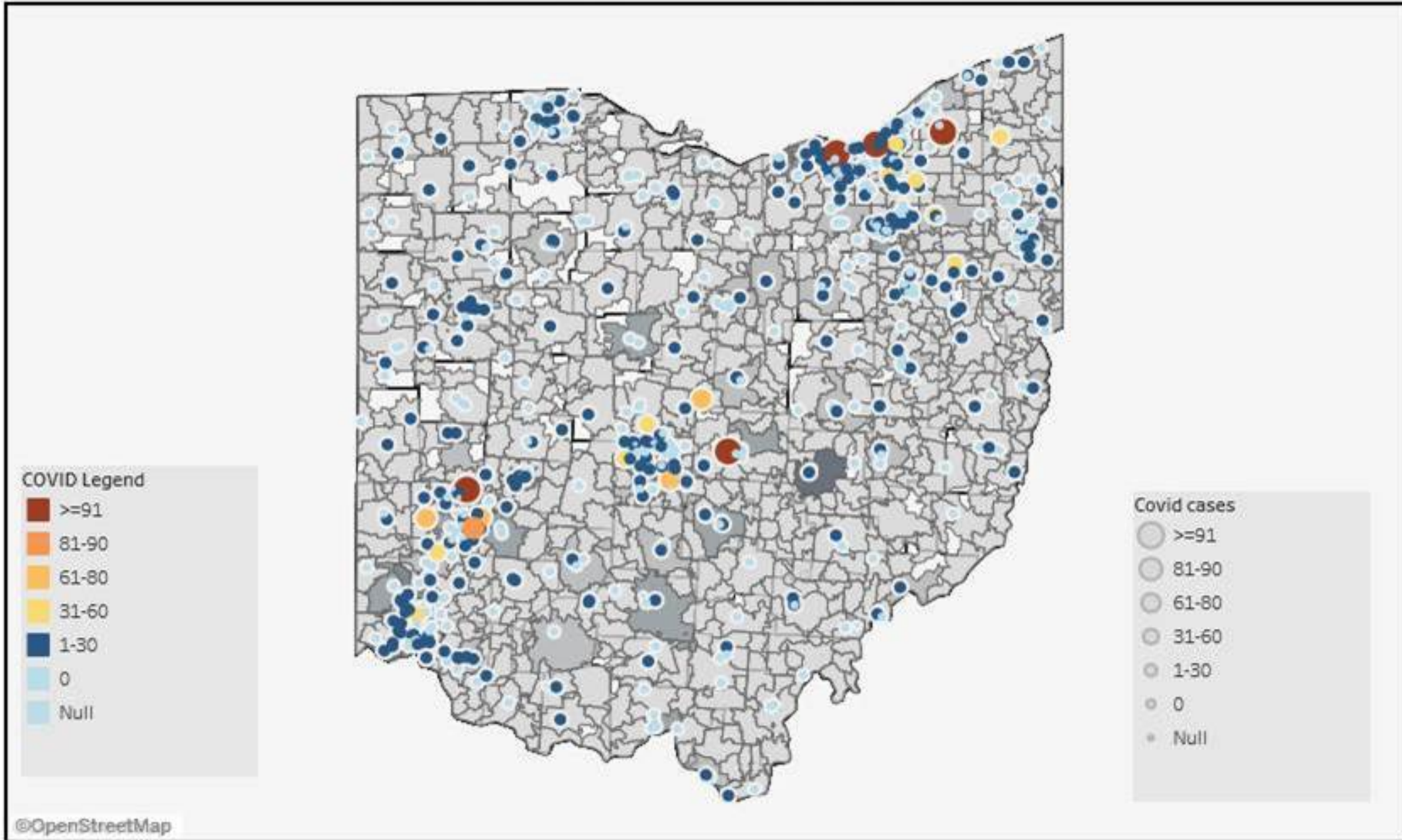

## COVID-19 Risk Factors with C19 Population

Now let's narrow in on just NFs with presumed exposures.

Areas with higher vulnerable populations means that there is a higher likelihood that someone from the community can inadvertently bring it into the congregate cares settings.

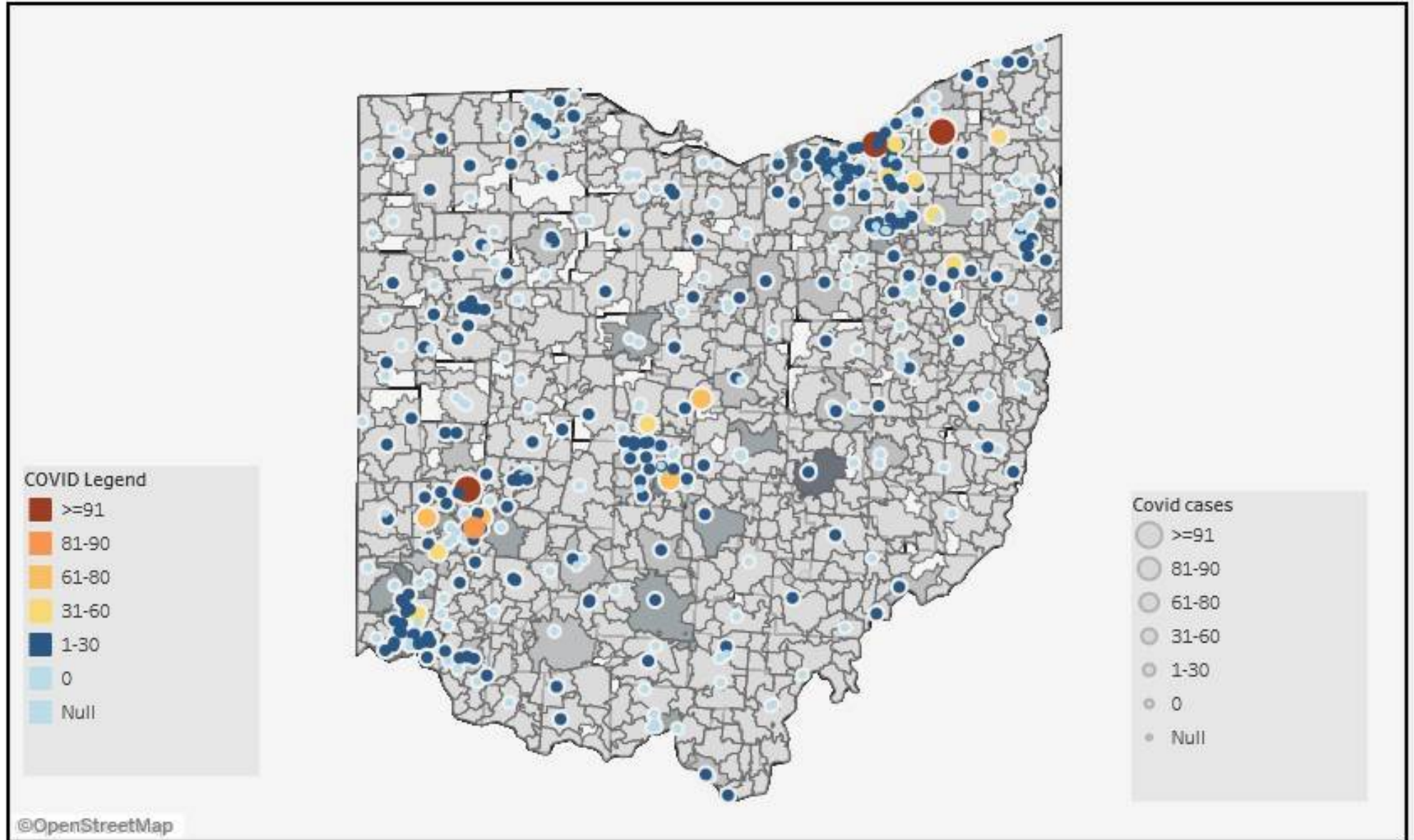

If we zoom into just south of the Dayton we see these concentrations.

You can see there are already varying sizes of outbreaks with underlying populations of higher risk throughout the community.

Each of these light blue facilities is at a higher risk of also seeing an outbreak. They are all right on top of each other.



If we look at those with low PPE in just one category (mask) we can see there are several facilities that are already seeing breakouts.

In the lower Dayton/Cinci area. You can pretty much guaranty that one facility (light blue) that has low PPE, near highly vulnerable populations, but still reporting no cases won't remain safe for very long.

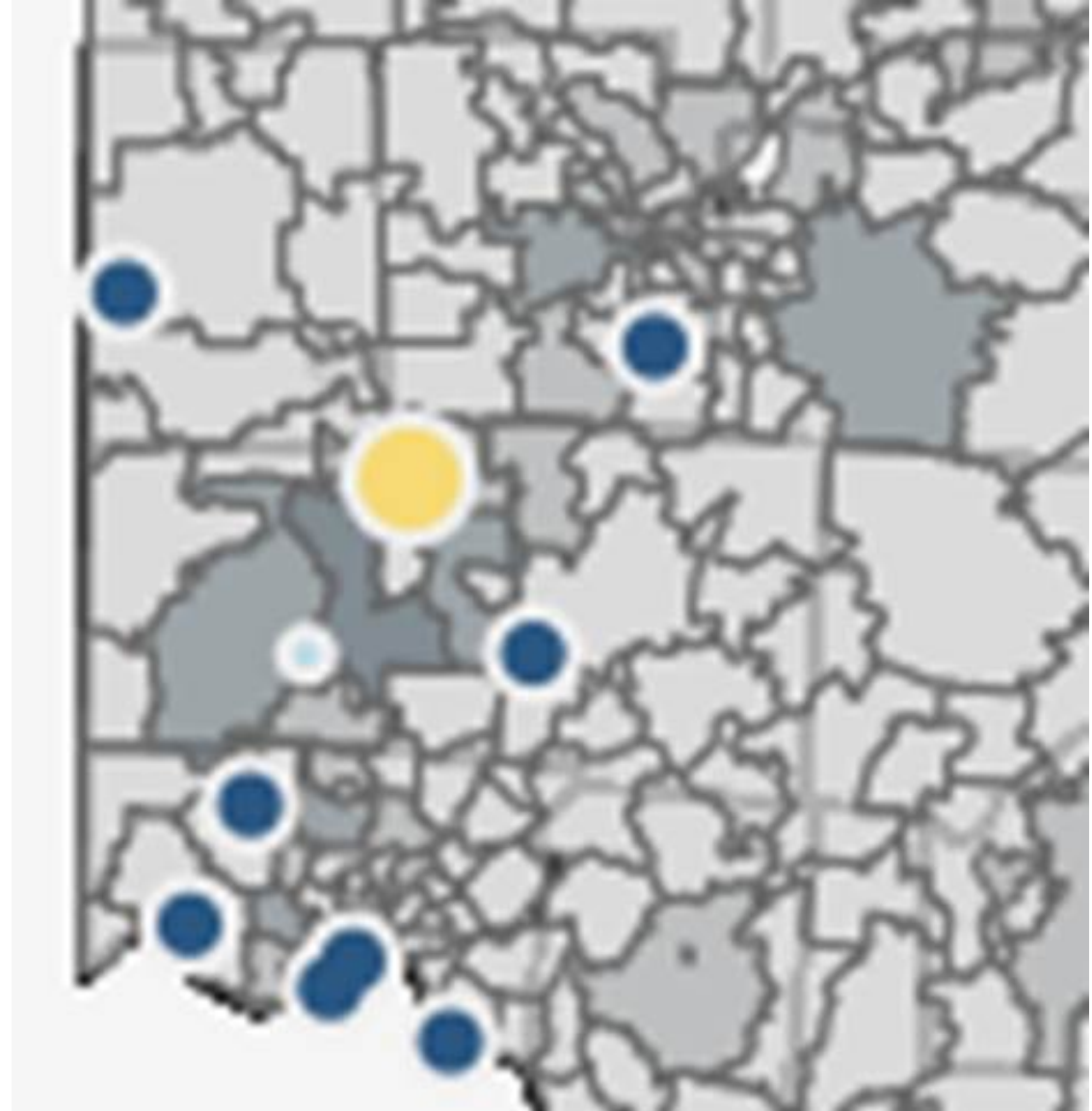

It is the same in rural counties.

Looking at Ross county we see this.

Several sites just starting to test and see results, with many others with no cases, but in high risk areas.

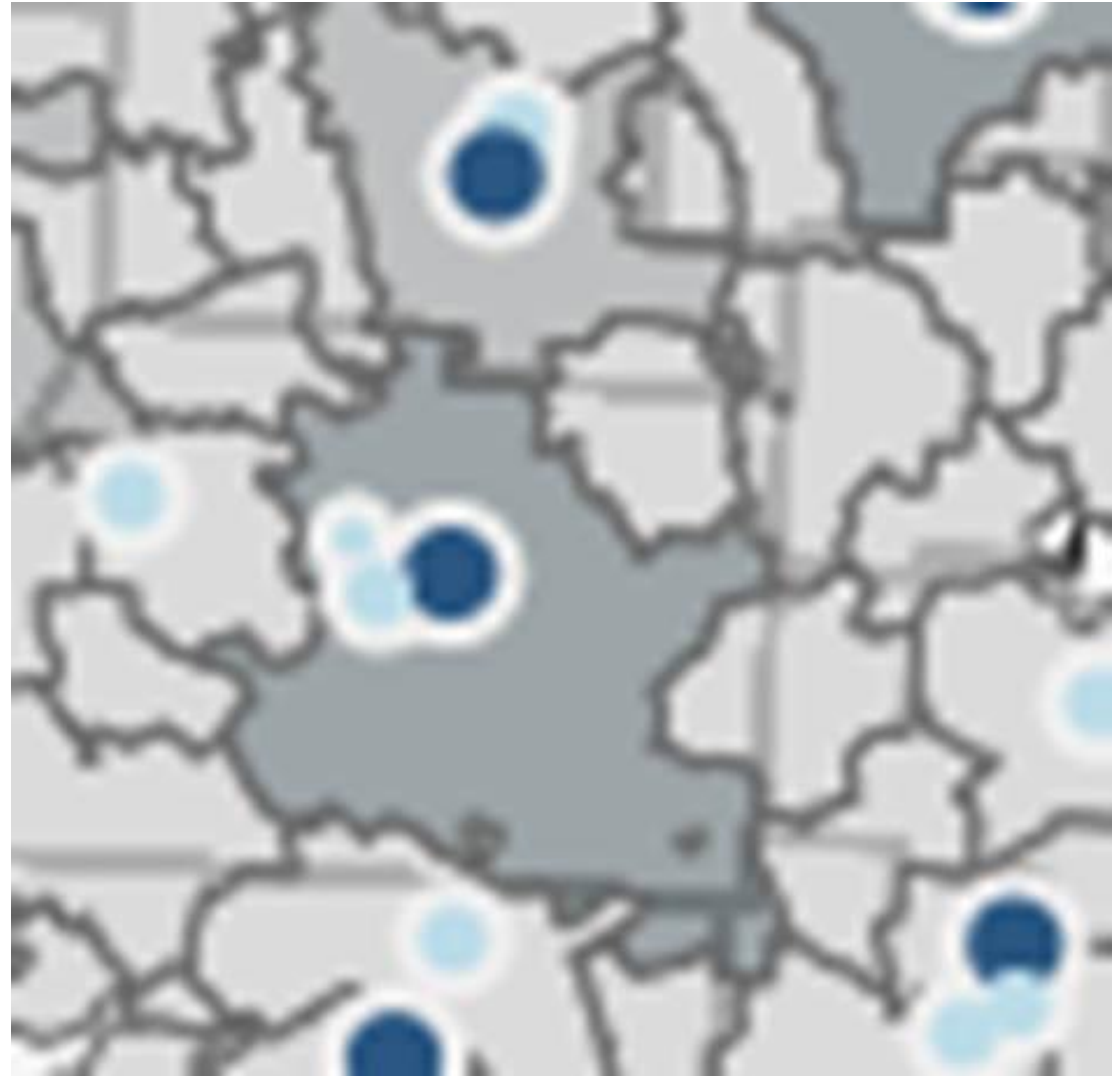

# Hospital-Community Collaborative Protocol

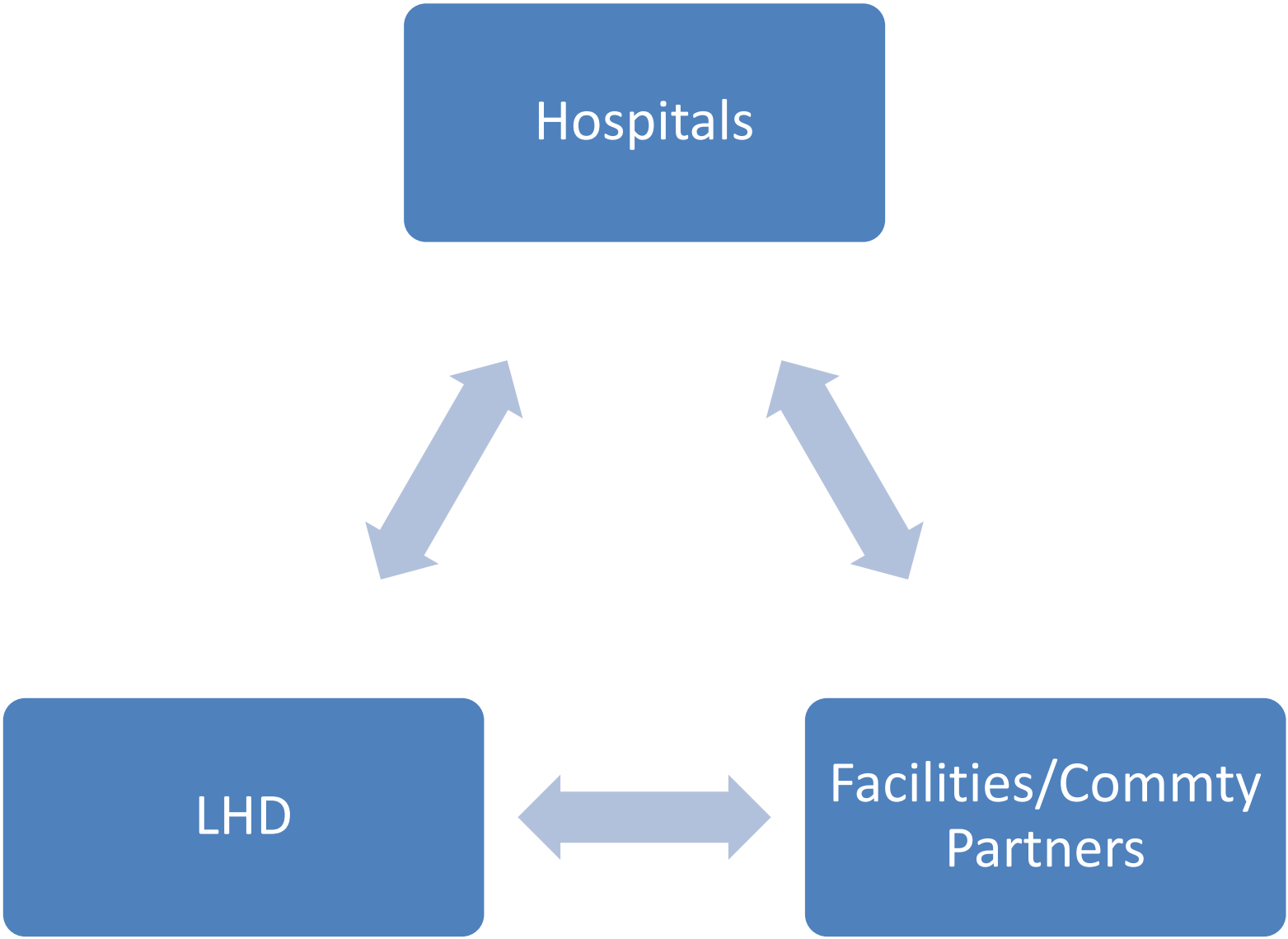



# Community LHD-Hospital-Facility Collaboration & Proposed State Alignment

COVID  
"WATCH  
DESK" &  
RAPID  
RESPONSE

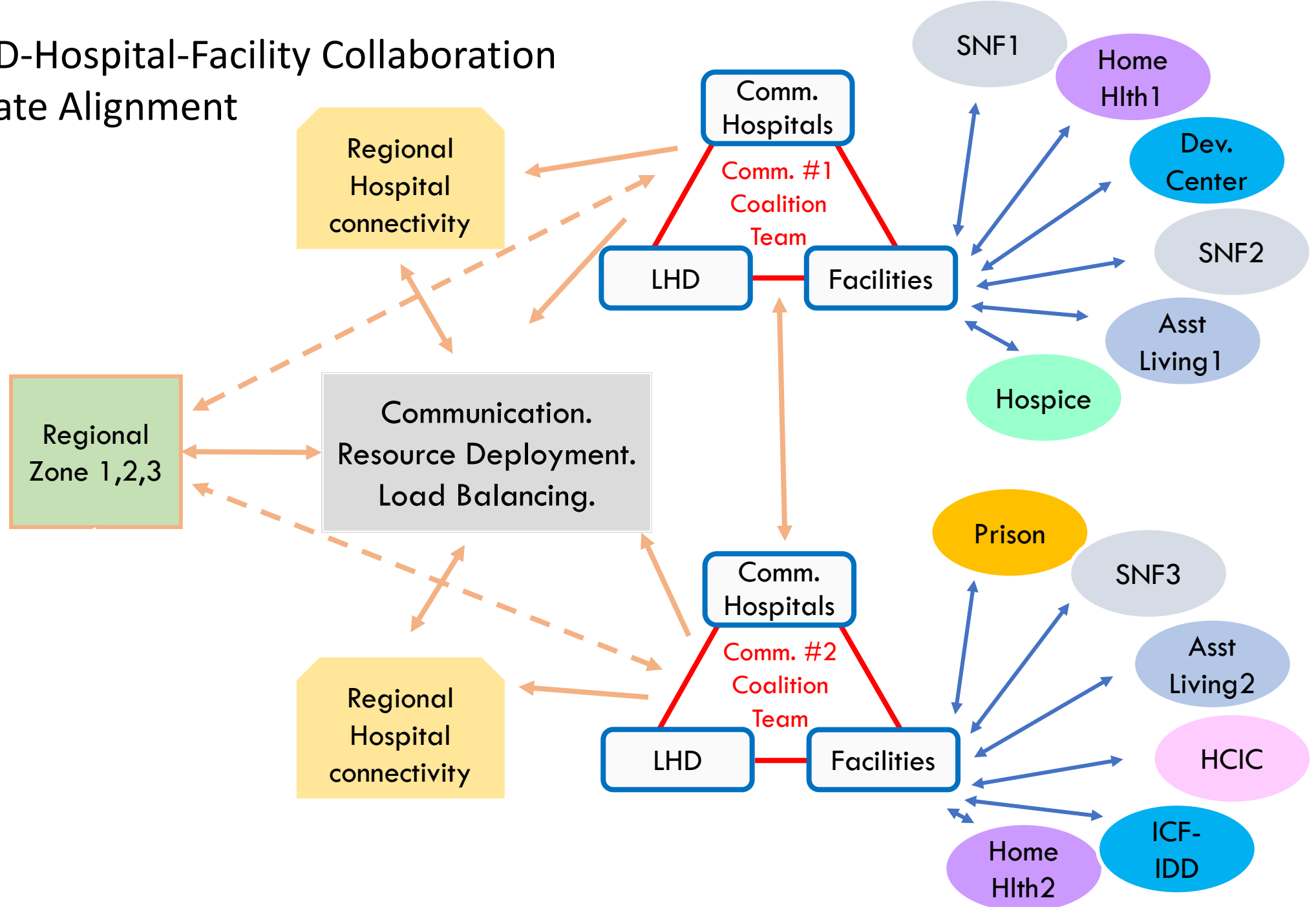

# **Purpose of Hospital-Facility-LHD Local Coalitions:**

## **Communication. Resource Deployment. Load Balance.**

- 1. Develop locally coordinated clinical support to ensure better care for the entire community**
  - » This process must build upon, complement, and extend existing local efforts. Not supplant.
  - » Must leverage each community's unique existing clinical and operational problem-solving capabilities.
- 2. Streamline real-time information sharing and communication**
- 3. Standardize approaches to improve clinical efficiency and results** in ways that match the unique characteristics of each community. Must involve work with local infectious disease and public health experts.
- 4. Maximize allocation and use of resources** based on broader identified areas of need (often focused on PPE and testing.)
- 5. This includes state level surveillance and monitoring, incl. guardrails for managing PPE & Testing** to ensure transparency and equitable access statewide.

# Functions of Local Coalitions

- **More comprehensive team building to better coordinate patient-centered clinical support for the entire community**
  - » Includes residents with and without COVID-19 infection, “hands-on” assistance
  - » Builds upon and extends existing clinical and operational problem-solving capacities, not replacing them
- **Further develop and communicate streamlined COVID-19-related information across all community care settings**
  - » Connects to other local coalitions for synergy, eventually rolling up to a whole health system view for Zone and State leaders
- **Align treatment approaches including how best to “Test and Treat in Place” while developing transfer and discharge efficiencies**
- **Agree on processes to utilize limited resources available to the entire community including testing, PPE, personnel, transportation and other scarcities**

## Health Care Isolation Centers (HCICs)

- Congregate care facilities are working with region/zone leadership to establish new HCICs that specialize in the care of patients who:
  - » Have been exposed to COVID-19 but are asymptomatic (quarantine) and/or
  - » Require treatment for COVID-19 confirmed or probable illness (isolation)
- To apply, the HCICs must submit joint letter with region/zone to confirm the zone needs to add capacity for quarantine and/or isolation
- HCICs will be regulated by the Ohio Department of Health
- Some HCICs will be eligible for payment from Ohio Medicaid
- Team of ODH/ODM staff will be available in each zone to assist

# Hospital-Community Collaborative Example

# COVID-19: 7 Pillars of Incident Management

## COVID-19 Incident/Emergency Management Pre-Plan (Long-Term Care / Post-Acute Care Facilities)

Team Building

Transmission Reduction

Triage Preparedness

Targeted Conversations

Telehealth Capabilities

Test & Treat in Place

Transitions of Care

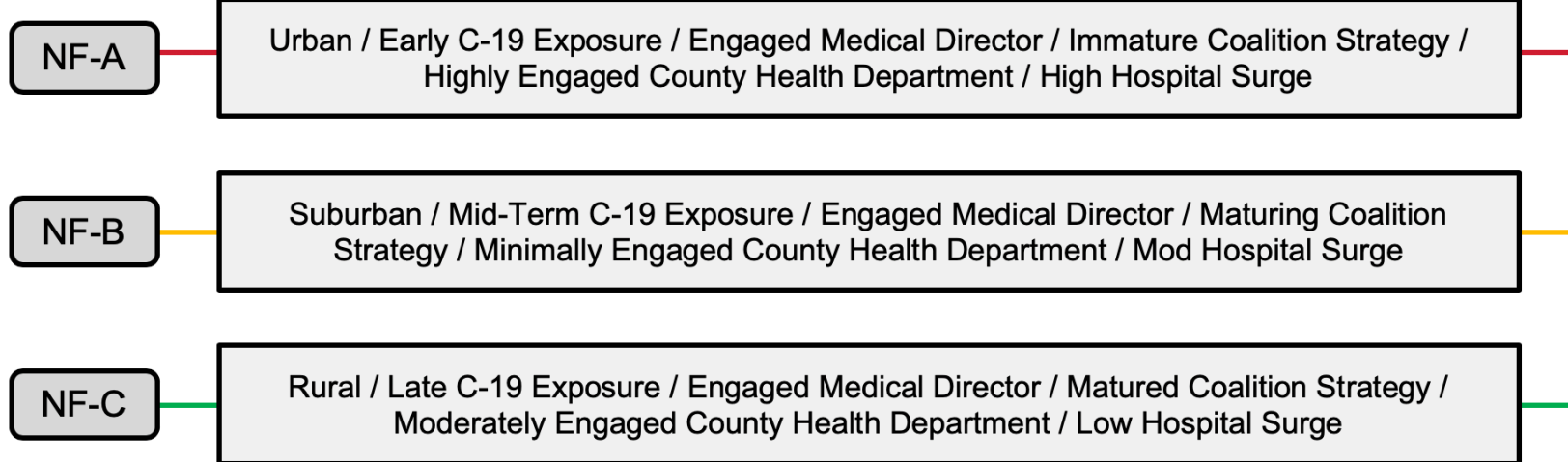

eggy

NF-A

Urban / Early C-19 Exposure / Engaged Medical Director / Immature Coalition Strategy / Highly Engaged County Health Department / High Hospital Surge

NF-B

Suburban / Mid-Term C-19 Exposure / Engaged Medical Director / Maturing Coalition Strategy / Minimally Engaged County Health Department / Mod Hospital Surge

NF-C



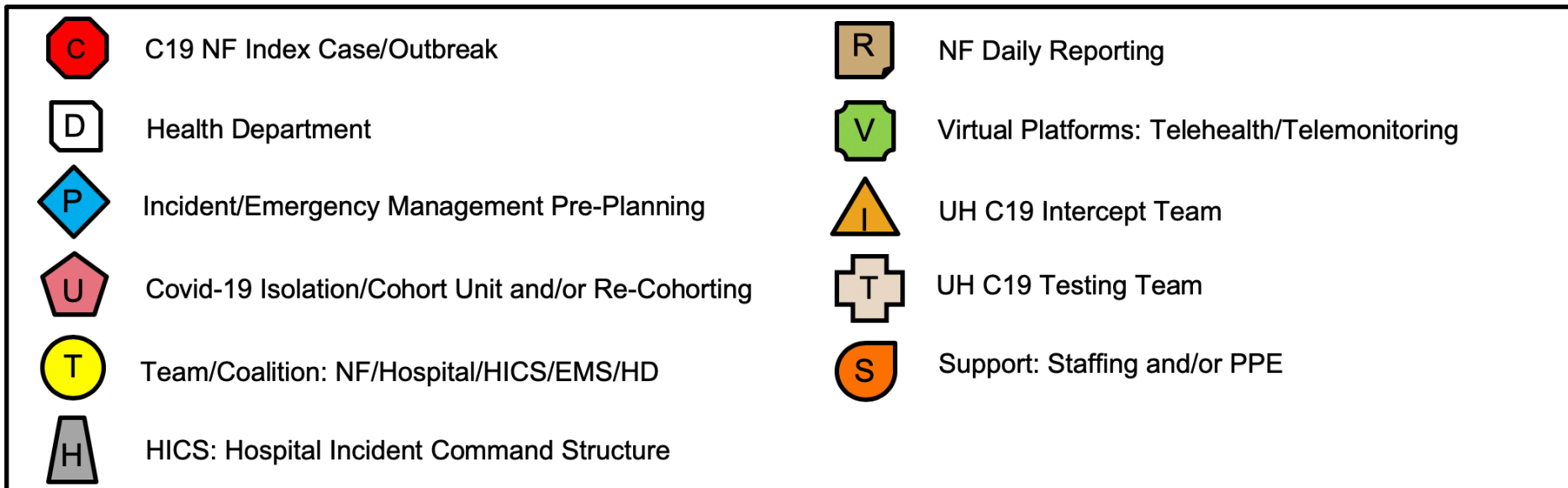





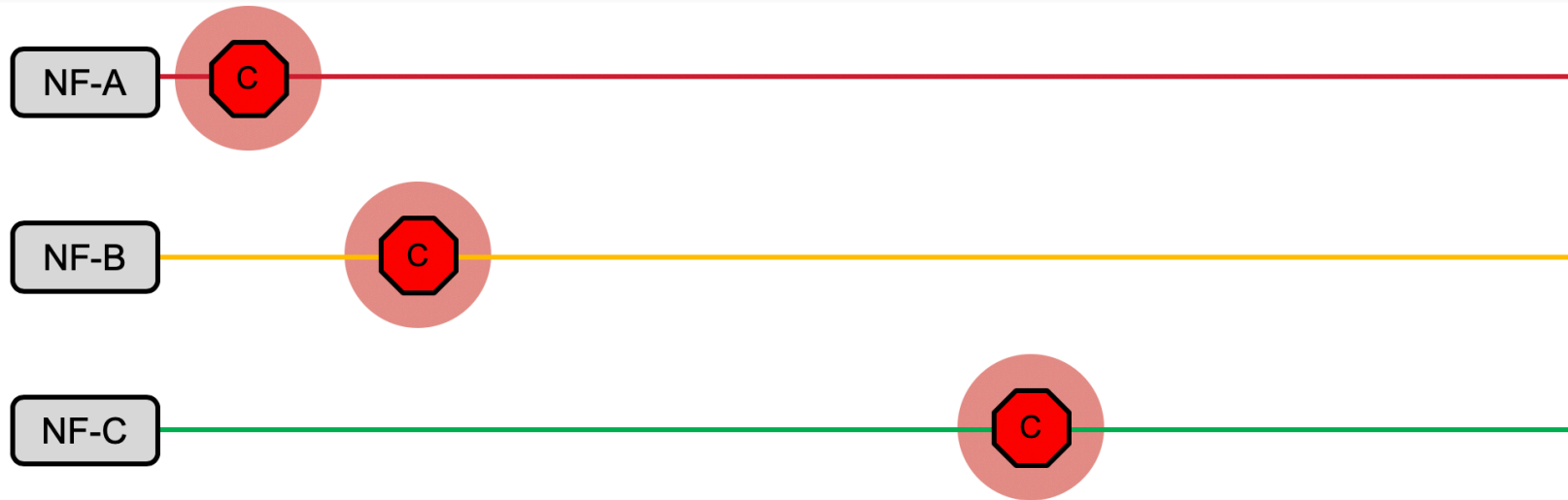

Rural / Late C-19 Exposure / Engaged Medical Director / Matured Coalition Strategy / Moderately Engaged County Health Department / Low Hospital Surge













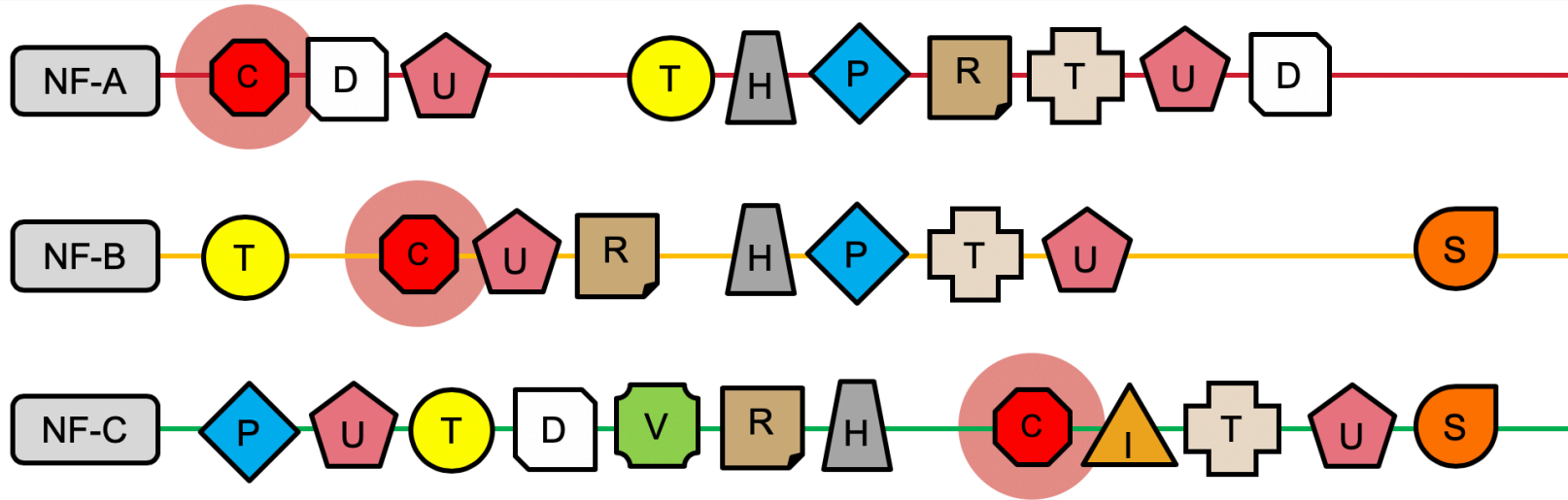



# COVID-19: Hospital/Nursing Facility Coalition Strategy











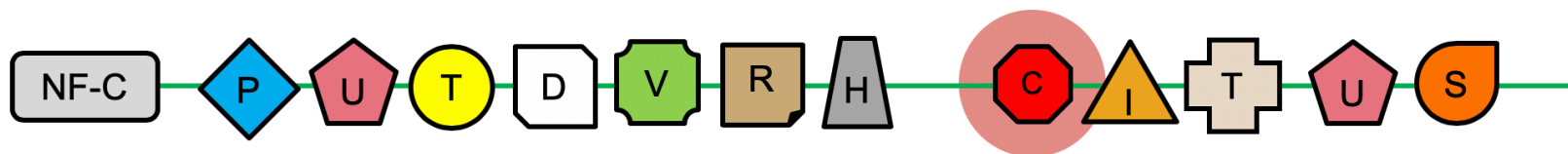



	C19 NF Index Case/Outbreak		NF Daily Reporting
	Health Department		Virtual Platforms: Telehealth/Telemonitoring
	Incident/Emergency Management Pre-Planning		UH C19 Intercept Team
	Covid-19 Isolation/Cohort Unit and/or Re-Cohorting		UH C19 Testing Team
	Team/Coalition: NF/Hospital/HICS/EMS/HD		Support: Staffing and/or PPE
	HICS: Hospital Incident Command Structure		

# COVID-19: Hospital/Nursing Facility Coalition Strategy











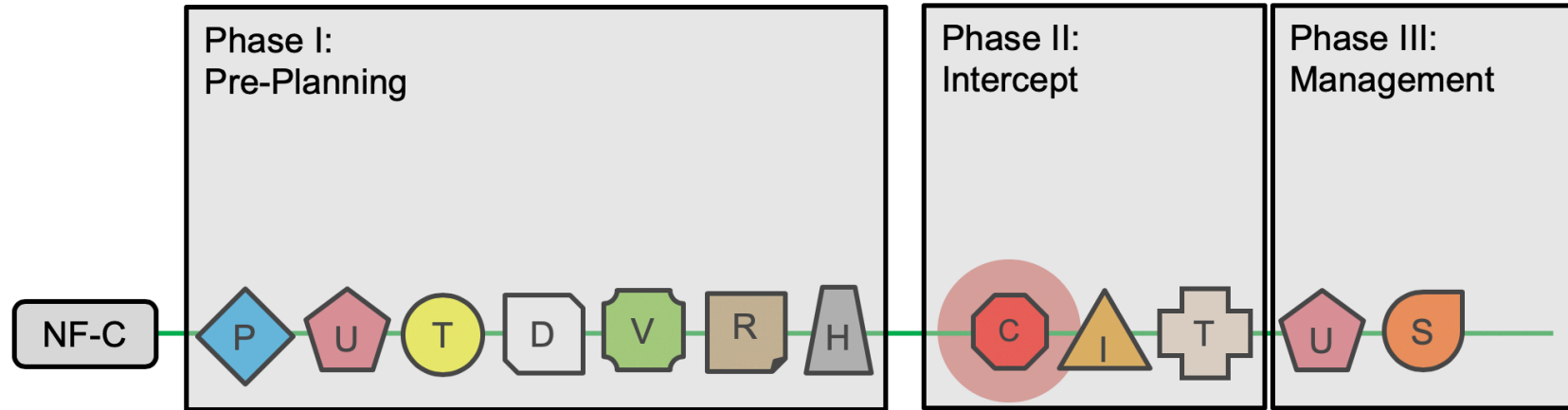



	C19 NF Index Case/Outbreak		NF Daily Reporting
	Health Department		Virtual Platforms: Telehealth/Telemonitoring
	Incident/Emergency Management Pre-Planning		UH C19 Intercept Team
	Covid-19 Isolation/Cohort Unit and/or Re-Cohorting		UH C19 Testing Team
	Team/Coalition: NF/Hospital/HICS/EMS/HD		Support: Staffing and/or PPE
	HICS: Hospital Incident Command Structure		



	C19 NF Index Case/Outbreak		NF Daily Reporting
	Health Department		Virtual Platforms: Telehealth/Telemonitoring
	Incident/Emergency Management Pre-Planning		UH C19 Intercept Team
	Covid-19 Isolation/Cohort Unit and/or Re-Cohorting		UH C19 Testing Team
	Team/Coalition: NF/Hospital/HICS/EMS/HD		Support: Staffing and/or PPE
	HICS: Hospital Incident Command Structure		

## Three (3) Critical Phases of Coalition-Based COVID-19 Incident Management



	C19 NF Index Case/Outbreak		NF Daily Reporting
	Health Department		Virtual Platforms: Telehealth/Telemonitoring
	Incident/Emergency Management Pre-Planning		UH C19 Intercept Team
	Covid-19 Isolation/Cohort Unit and/or Re-Cohorting		UH C19 Testing Team
	Team/Coalition: NF/Hospital/HICS/EMS/HD		Support: Staffing and/or PPE
	HICS: Hospital Incident Command Structure		

## Three (3) Critical Phases of Coalition-Based COVID-19 Incident Management

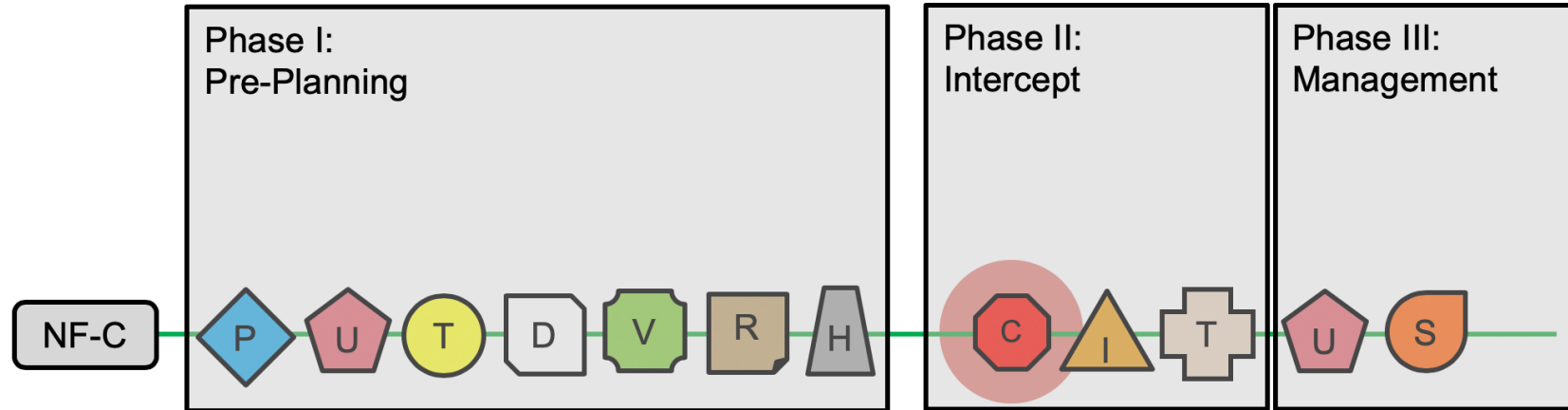

**Phase I:** Preparing the NF; Forming the coalition; Formalizing the strategy

**Phase II:** Rapid Response to a NF COVID-19 Index Case; Re-assess the facility and resident population; Retraining the facility staff and medical team

**Phase III:** Population Health Strategy (Clinical Practice + Public Health)

- Centralized communication, reporting and coordination of resources
- Monitoring of facility/staff practices; re-assess resident advance directives
- Coalition-based NF needs assessment & support (load-balancing & resource allocation – staffing and PPE)
- Hospital surge preparedness & strategy (minimize emergent/911 transport & facilitate direct hospital admit)
- Clinical management: Testing, treatment & re-cohorting of the NF population
- Safe return to work & return to NF congregate population

## Next Steps

- **Meet at zone, region, and community levels – develop actionable community collaboration**
  - » Honest assessment of your community
  - » Develop community solutions that respect dignity of individuals
- **State level strategic guardrails around equitable PPE, testing**
  - » Surveillance and monitoring for transparency in statewide effectiveness
- **State will work with hospitals & associations to provide additional supports to accelerate meaningful partnerships**

Thank you for attending

